

# display construction solutions guide

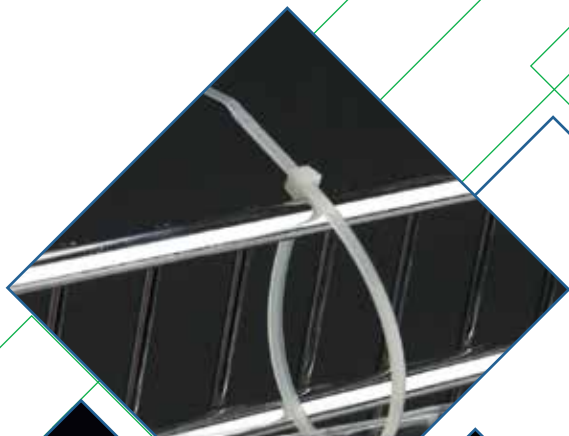

**siffron**<sup>®</sup>

www.siffron.com | 800.422.2547



Pallet Display Clip / 4-Way

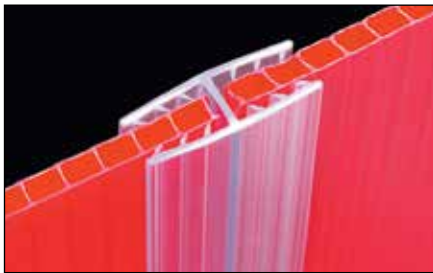

SuperGrip® 180° Panel Former



Channel Mount with Adhesive



Splash Rollz™ for Pegboard

## Display Construction

### Maximize impact with minimal use of space

Display construction is the bread and butter of every retail store environment. Keep your graphics, labels, and store displays looking their best by utilizing the full arsenal of siffron's display construction catalog. With hundreds of SKUs to select from, we are guaranteed to have what retailers are looking for when it comes to:

- ◆ Fasteners and adhesives
- ◆ Corrugated box displays
- ◆ Plastic hooks
- ◆ Shelf supports
- ◆ Pallet display
- ◆ Display accessories – casters, clips, and adapters

This guide includes a wide variety of products to help you maximize the impact of your retail displays.



Pallet Guards . . . . .	4
Shelf Supports . . . . .	5
Panel Formers . . . . .	7
Turntables . . . . .	11
Display Feet / Casters . . . . .	12
Handles . . . . .	13
Display Poles and Accessories . . . . .	14
Locking Straps . . . . .	17
Beaded Chain. . . . .	18
Adapters. . . . .	19
Adhesive Adapters. . . . .	20
Adhesives. . . . .	22
Magnets . . . . .	25
Bumpers. . . . .	26
Fasteners . . . . .	27
Push Pins . . . . .	33
Splash Rollz™ . . . . .	34







### Pallet Wrap

Put the finishing touch on your pallet display by concealing the base of your existing pallet to make it more attractive and draw more attention to your products. Pallet Wrap is designed to wrap around the bottom of your pallet display base to keep it hidden and provide a visually pleasing addition to your case stack.

- Elastic bands are adjustable to fit most common pallet sizes.
- Easy, one-person installation.
- More durable than paper or corrugated wraps.
- Adjustable to fit most full and half pallet sizes.

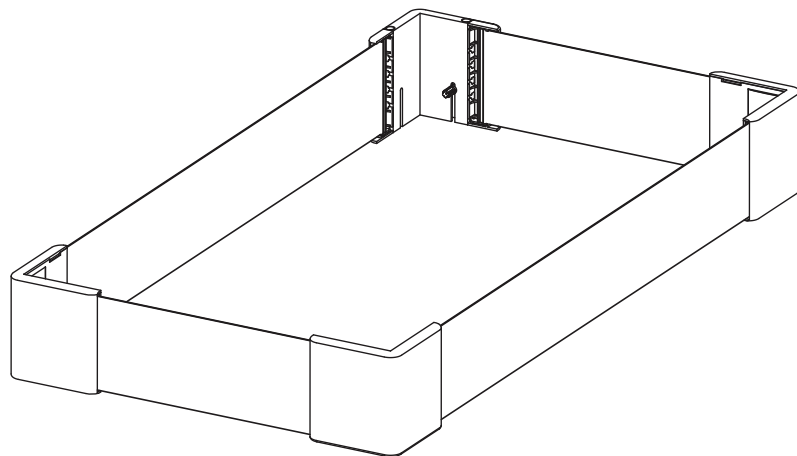

Item No.	Ref. No.	Dimensions	Finish	Pack
7909852667	RAPS-135	6.5" high	Black	1

### Corr•A•Clip® Shelf Supports CC100 and CC200

- Single capacity holds a single thickness of .125" B-flute corrugated shelf construction and .125" display wall, for a total .25" capacity
- Double capacity holds a doubled thickness of .25" B-flute corrugated and .125" display wall, for a total .375" capacity
- CC200 offers greater structural support with angled brace
- Available with adhesive to permanently secure shelf to clip
- Support Tube available to strengthen shelves
- 1.5" length
- Clear PVC



Item No.	Ref. No.	Wall Cap.	Style	Pack
8200735101	RCSS-100	.25" Single	CC100 w/o adhesive	1
8200735103	RCSS-100-ADH	.25" Single	CC100 w/ adhesive	1
8200735102	RCSS-200	.375" Doubled	CC100 w/o adhesive	1
8201973101	RCSS-100-AB	.25" Single	CC200 w/o adhesive	1
8201973103	RCSS-100-AB-ADH	.25" Single	CC200 w/ adhesive	1
8201973102	RCSS-200-AB	.375" Doubled	CC200 w/o adhesive	1

Additional lengths and colors can be made to order (minimum quantities apply.)

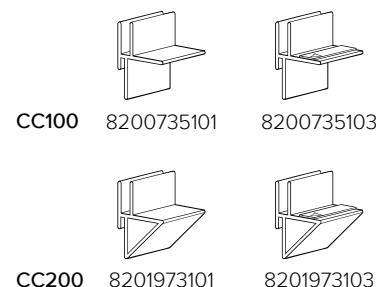

### Corr•A•Clip® Shelf Supports CC300

- Fits up to .125" B-flute corrugated
- 2" length
- Has holes along the side, allowing glue to seep through for stronger hold
- Natural polypropylene



Item No.	Ref. No.	Style	Finish	Pack
8208077500	RCSS-15-20	Standard (Vertical)	Natural	1

Additional colors can be made to order (minimum quantities apply.)

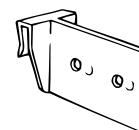

### Corr•A•Clip® Shelf Supports CC400

- Two-piece shelf support allows for pre-attachment to corrugated displays prior to shipping
- Pre-attachment saves assembly time and allows display to be shipped flat
- Holes allow glue to seep through for stronger hold
- Fits up to .1875" C-flute corrugated
- Available in two sizes and in two-piece or one piece
- White polypropylene



Now available as individual items

Item No.	Ref. No.	Style	Dimensions	Pack
8203788801	RCSS-178-214	Two-piece, 2 Holes	1.875" H x 2.25" L	1
8203788802	RCSS-238-214	Two-piece, 5 Holes	2.375" H x 2.25" L	1
8203788872	-	Support, 2 Holes	1.86" H x 2.25" L	1
8203788873	-	Track for 2 Hole Support	2.6" H	1
8203788876	-	Support, 5 Holes	2.25" H x 2.25" L	1
8203788871	-	Track for 5 Hole Support	3" H	1

Additional colors can be made to order (minimum quantities apply.)

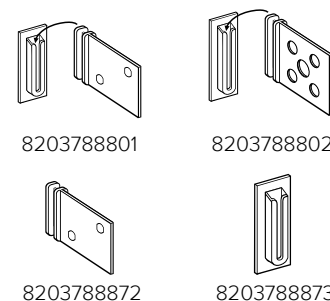



8202270001

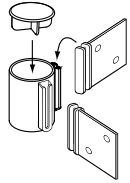

8200187301

## Corr•A•Clip® Modular Shelf Supports CC500

- Provides four-sided shoppability
- Cap available to provide finished look to top tier
- Shelves can be pre-attached to CC500 prior to shipping
- Fits 1.75" O.D. Display Poles
- Holds up to .1875" C-Flute corrugated
- 2.5" H; white polypropylene

Item No.	Ref. No.	Style	Finish	Pack
8200187301	-	Shelf Support	White	1
8202270001	-	Cap	White	1

*Additional Shelf Support colors can be made to order (minimum quantities apply.)*

*Additional Display Pole sizes and colors can be made to order (minimum quantities apply.)*

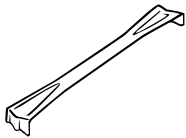

## Corr•A•Clip® Support Tube

- Metal tube provides support for corrugated shelving
- Inserts into pre-punched slots below corrugated shelf
- Fits any corrugated panel thickness
- Available in Made To Order sizes – call for details (please be prepared to provide desired tube diameter and length)
- .75" diameter, 28-gauge metal with .75" legs

Item No.	Ref. No.	
8204977313	-	For Details - Minimum quantities and lead times apply



## Flute Wire

- Use flute wire to join corrugated displays or add signs to displays
- Slides into the fluting of corrugated materials and bends as needed
- Available for B- and C-Flute corrugate
- Zinc-coated metal

Item No.	Ref. No.	Style	Dimensions	Pack
8111692751	-	B Flute	6" L	1
8111692753	-	B Flute	12" L	1
8111692752	-	B Flute	24" L	1

*Additional sizes can be made to order (minimum quantities apply.)*

## SuperGrip® Hinged Panel/Sign Holder

- Features SuperGrip® brand holding power for displays and signs
- Flexible hinge joins panels flush, parallel or at an angle
- Both sides hold material .015" to .250" thick
- Clear PVC

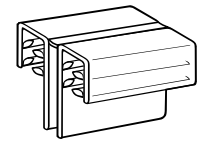
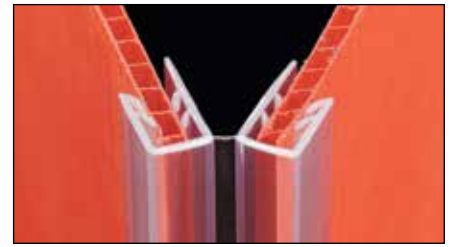

Item No.	Ref. No.	Dim.	Capacity	Finish	Pack
1511031801	-	1" L	.015"-.250"	Clear	1

Additional lengths and colors can be made to order (minimum quantities apply.)

## SuperGrip® Hinged Panel Former

- Flexible hinge permits configuration of panels at different angles
- Conceals unfinished panel edges
- Capacity is .125" to .1875" or .1875" to .25"
- White or clear PVC

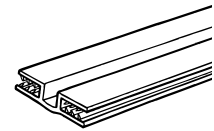
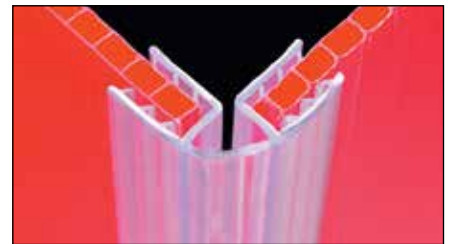

Item No.	Ref. No.	Dim.	Capacity	Finish	Pack
8112270600	-	48" L	.125"-.1875"	White	1
8112270601	-	48" L	.125"-.1875"	Clear	1
8116072201	-	48" L	.1875"-.25"	Clear	1

Additional lengths and colors can be made to order (minimum quantities apply.)

## SuperGrip® 60° Panel Former

- Two-way connector with fixed 60° angle
- Conceals unfinished panel edges
- Capacity is .125" to .1875" or .1875" to .25"
- White or clear PVC

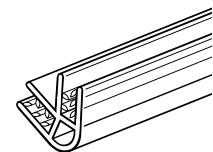
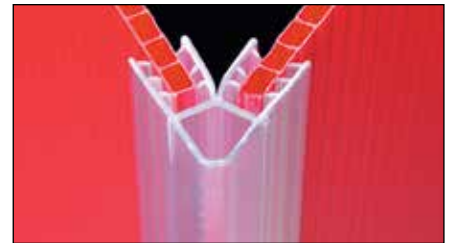

Item No.	Ref. No.	Dim.	Capacity	Finish	Pack
8112394600	-	48" L	.125"-.1875"	White	1
8112394602	-	48" L	.125"-.1875"	Clear	1
8116493200	-	48" L	.1875"-.25"	White	1
8116493201	-	48" L	.1875"-.25"	Clear	1

Additional lengths and colors can be made to order (minimum quantities apply.)

## SuperGrip® 90° Panel Former

- Two-way connector with fixed 90° angle
- Conceals unfinished panel edges
- Capacity is .125" to .1875" or .1875" to .25"
- White or clear PVC

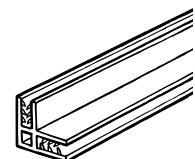
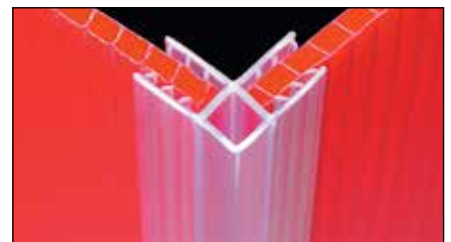

Item No.	Ref. No.	Dim.	Capacity	Finish	Pack
8111692700	-	48" L	.125"-.1875"	White	1
8111692707	-	48" L	.125"-.1875"	Clear	1
8117296100	-	48" L	.1875"-.25"	White	1
8117296101	-	48" L	.1875"-.25"	Clear	1

Additional lengths and colors can be made to order (minimum quantities apply.)

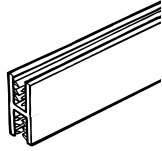
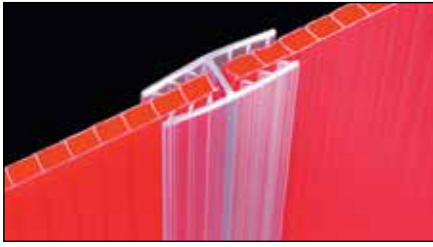

### SuperGrip® 180° Panel Former

- Fixed 180° design allows you to join two panels
- Conceals unfinished panel edges
- Capacity is .125" to .1875" or .1875" to .25"
- White or clear PVC

Item No.	Ref. No.	Dim.	Capacity	Finish	Pack
8112330800	-	48" L	.125"-.1875"	White	1
8112330802	-	48" L	.125"-.1875"	Clear	1
8118033200	-	48" L	.1875"-.25"	White	1
8118033202	-	48" L	.1875"-.25"	Clear	1

Additional lengths and colors can be made to order (minimum quantities apply.)

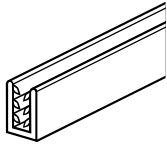
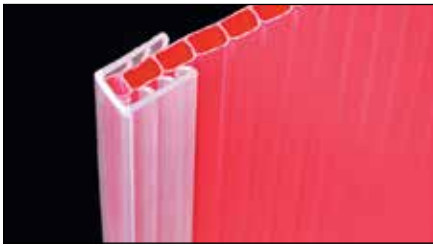

### SuperGrip® "U" Channel Panel Former

- Provides a clean, finished edge to display materials
- Capacity is .125" to .1875" or .1875" to .25"
- White or clear PVC

Item No.	Ref. No.	Dim.	Capacity	Finish	Pack
8115266600	-	48" L	.125"-.1875"	White	1
8115266601	-	48" L	.125"-.1875"	Clear	1
8116662501	-	48" L	.1875"-.25"	Clear	1

Additional lengths and colors can be made to order (minimum quantities apply.)

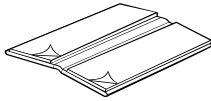
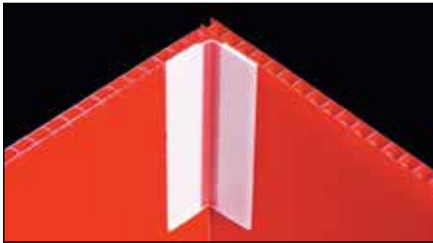

### Extruded Hinge with Adhesive

- Flexible hinge allows you to configure panels at any angle
- Adhesive strips adhere to most flat surfaces
- 180° flexibility in either direction
- Clear PVC

Item No.	Ref. No.	Dim.	Finish	Pack
8202735401	-	1.25" W x 3" L	Clear	1
8202735425	-	2" W x 5" L	Clear	1

Additional lengths can be made to order (minimum quantities apply.)

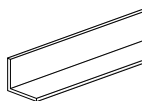

8204394601

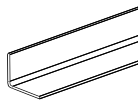

8206264001

### "L" Bracket

- Bracket allows you to configure panels at 90° angle
- Available with or without flexible hinge
- Attach to panels with glue, double-sided tape or screws
- Hinged option has 1" W mounting area on each side of flexible hinge
- Non-hinged option has .75" W mounting area on each side of 90° angle
- Clear PVC

Item No.	Ref. No.	Style	Dim.	Finish	Pack
8204394601	-	w/o Hinge	48" L	Clear	1
8206264001	-	w/ Hinge	48" L	Clear	1



### SuperGrip® 2-Way 60° Panel Former

- Two-way connector with fixed 60° angle
- .125" capacity
- Clear PVC

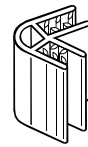
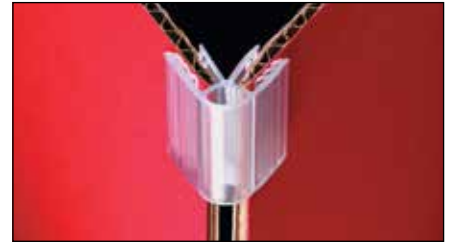

Item No.	Ref. No.	Dimensions	Finish	Pack
8118088200	-	1" L	Clear	1

Additional lengths and colors can be made to order (minimum quantities apply.)

### SuperGrip® 2-Way 90° Panel Former

- Two-way connector with fixed 90° angle
- .125" capacity
- Clear PVC

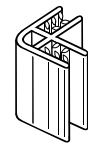
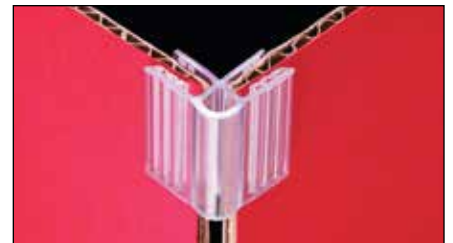

Item No.	Ref. No.	Dimensions	Finish	Pack
8118110300	-	1" L	Clear	1

Additional lengths and colors can be made to order (minimum quantities apply.)

### SuperGrip® H Clip 111

- For connecting panels horizontally and vertically and to attach signs above displays or fixtures
- Two sizes available
- 8117602701 and 02 hold material up to .080" thick
- 8117602703 holds material up to .125" thick
- Clear PVC

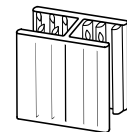
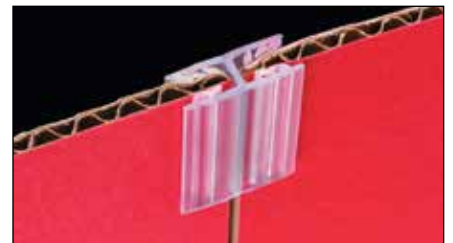

Item No.	Ref. No.	Capacity	Dim.	Pack
8117602701	-	.080"	1" L	1
8117602702	-	.080"	3" L	1
8117602703	-	.125"	1" L	1

Additional lengths and colors can be made to order (minimum quantities apply.)

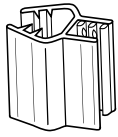

### SuperGrip® H Clip 122

- Two-way, 180° clip connects panels of varying thicknesses
- Holds material up to .080" thick in one side, and .125" to .1875" thick in other side
- 1" overall height
- Clear PVC

Item No.	Ref. No.	Dimensions	Finish	Pack
8112733301	RFG2-016-1	1" L	Clear	1
8112733302	RFG2-016-150	1.5" L	Clear	1

Additional lengths and colors can be made to order (minimum quantities apply.)

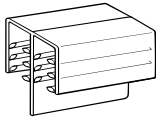
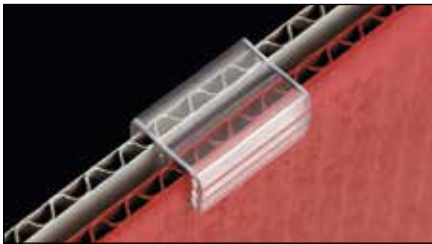

### SuperGrip® .1875" Panel Holder

- Ideal for connecting panels, bins and more
- Features SuperGrip® brand holding power to grip panels
- Holds material from .1875" to .25" thick
- Clear PVC

Item No.	Ref. No.	Dimensions	Finish	Pack
8116202801	-	1" L	Clear	1

Additional lengths and colors can be made to order (minimum quantities apply.)

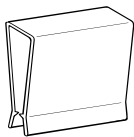
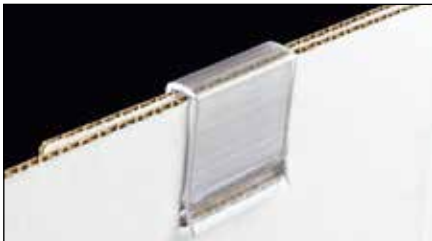

### Pallet Display Clip

- Connect corrugated display panels without adhesive
- Ideal for palletized display panel edges, including bulk merchandise displays
- Fits 2" W slots in display panels for a secure hold
- Holds material up to .375" thick
- Clear PVC

Item No.	Ref. No.	Dimensions	Finish	Pack
1508648200	-	2" H x 2" L x .4375" D	Clear	1

Additional lengths and colors can be made to order (minimum quantities apply.)

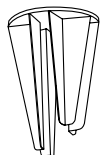

### Pallet Display Clip/4-Way

- Joins display boxes and palletized cartons securely and seamlessly
- Clip easily slides over boxes' shared corners
- Keeps display boxes in place to prevent slipping and to ensure customer safety
- Adds strength and support to stacked cartons
- Holds up to two single-wall A-Flute panels
- 2" diameter clip
- Clear plastic

Item No.	Ref. No.	Dimensions	Finish	Pack
8208648400	-	3.125" L	Clear	1

Additional colors can be made to order (minimum quantities apply.)

## Turntables/Metal

- Create revolving displays to enhance visibility and accessibility of merchandise
- Can be mounted to display bases through integrated holes for a stable base
- Designed to provide quiet rotation
- Available in square and round styles
- Available in multiple sizes; Made To Order sizes also available (minimum quantities and lead times apply)
- Durable steel construction provides a long-lasting display solution

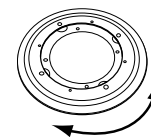
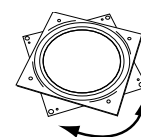

8206382502

8206382504

Item No.	Ref. No.	Dimensions	Style	Pack
8206382502	-	6"	Square	1
8206382504	-	12"	Round	1

Additional sizes can be made to order (minimum quantities apply.)

## Turntables/Plastic

- Showcase merchandise on revolving displays for maximum visibility and accessibility
- High-quality turntable can be attached to displays and fixtures to provide a sturdy base
- Designed to provide a quiet rotation
- Available with and without mounting holes to attach with hardware or adhesive pads
- Available in multiple sizes; Made To Order sizes also available (minimum quantities and lead times apply)
- 8207527802 is clear polystyrene; 8207527804 is clear PETG

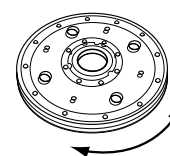

8207527802

8207527804

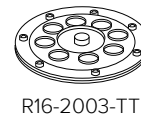

R16-2003-TT

Item No.	Ref. No.	Dimensions	Finish	Pack
8207527802	R16-2015-TT	5.5" W x .5" H	Clear	25
8648745675	R16-2003-TT	8.5" W x .5" H	Clear	25
8207527804	R16-2004-TT	12" W x .5" H	Clear	25

DISPLAY CONSTRUCTION

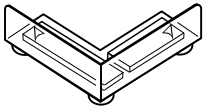

### Floor Stand Corner Glide

- Add mobility to fixtures on carpet or hard flooring
- Fits garment fixtures, corrugated displays and floor stands
- Foam adhesive tape secures Glide to display
- Each side 2.5" from corner
- Clear ABS

Item No.	Ref. No.	Finish	Pack
8201002102	-	Clear	1

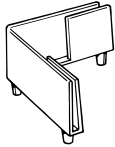

### Rigid Display Foot 2215

- Corner style three-point display foot secures and protects display corners at a 90° angle, .5" above the floor; each side 2.5" from corner
- Holds up to .1875" corrugated
- White polystyrene

Item No.	Ref. No.	Finish	Pack
8207528800	-	White	1

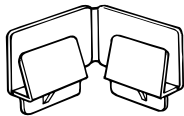

### Flexible Display Foot 2217

- Protects display base while permitting corners of displays to flex
- Lifts displays .5" above the floor
- Holds up to .3125" corrugated
- Each side 1.875" from corner
- Natural polypropylene

Item No.	Ref. No.	Finish	Pack
8202466600	-	Natural	1



### Plastic Master Caster

- Durable, smooth-running caster gives displays maximum mobility
- Creates moveable displays in minutes
- Adheres to displays with permanent adhesive
- 1.25" diameter wheel
- Capacity: 60 lb per caster
- Black HIPS

Item No.	Ref. No.	Dimensions	Finish	Pack
8208105500	-	2" x 2"	Black	1



### Swivel Display Caster SDC-2

- Durable, smooth-running caster gives displays maximum mobility
- Supports total of 160 lb distributed among four wheels
- Available in locking and non-locking styles
- Holds up to .25" A-Flute corrugated
- 3.375" W casters are unassembled; polycarbonate/SAN/Nylon
- Sold in sets of four

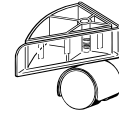

8201712000

Item No.	Ref. No.	Style	Finish	Pack
8201712000	-	Non-locking	Black	4

### Twin Wheel Caster

- Durable, smooth-running caster creates moveable displays in minutes
- Two 1.5625" diameter wheels with .75" stem
- Available in non-locking style, and locking style to immobilize display
- Capacity: 60 lb per caster
- Black nylon

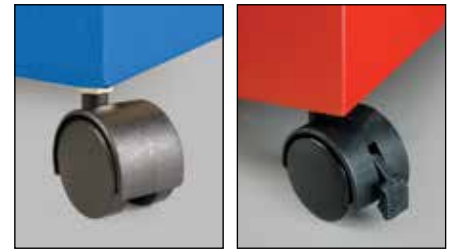

8201711002



8201711003

Item No.	Ref. No.	Style	Finish	Pack
8201711002	-	Non-locking	Black	1
8201711003	-	Locking	Black	1

### Display Caster DC-1

- Lifts heavyweight displays .75" off the floor
- Protects and assists when moving displays
- Capacity: 100 lb per caster
- Attaches to flat bottom displays with permanent adhesive
- Rounded contour allows displays to glide easily
- Natural polypropylene



Item No.	Ref. No.	Dimensions	Finish	Pack
8202174500	-	2" x 2"	Natural	1

Additional colors can be made to order (minimum quantities apply.)

### Packaging Handles

- Lightweight style holds up to 15 lb
- Heavy-Duty style holds up to 45 lb
- Backer Washers are available for added durability
- Black or white low density polyethylene

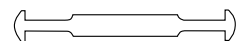

1504545400



1503327802



1503327851

Item No.	Ref. No.	Style	Capacity	Finish	Pack
1504545401	-	Handle	White	Up to 15 lb	1
1504545400	-	Handle	Black	Up to 15 lb	1
1504545406	-	Handle	White	Up to 30 lb	1
1503327802	-	Handle	Black	Up to 45 lb	1
1503327851	-	Back Washer	White	n/a	1

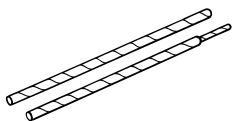

### Display Pole

- Two-piece, 6-foot long pole, available in four diameters
- Inner core holds pole pieces securely together
- Shipping length of poles: 39"
- White or black litho (paper)

Item No.	Ref. No.	Pole	O.D.	I.D.	Finish	Pack
8707939600	-	A	1.75"	1.468"	White	1
8701858830	-	A	1.75"	1.468"	Black	1
8702467100	-	B	1.5"	1.25"	White	1
8701858823	-	B	1.5"	1.25"	Black	1
8701858802	-	D	1"	.843"	White	1

Additional sizes and colors can be made to order (minimum quantities apply.)

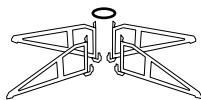

### Molded Plastic Display Foot

- Lightweight feet securely hold display poles
- Ideal alternative to wire feet; eliminates wire residue on display poles
- Use with 1.75" O.D. Display Poles (above)
- 26" span
- Black plastic

Item No.	Ref. No.	Fits Pole	Pole O.D.	Pack
8701592601	-	A	1.75"	1

Additional sizes can be made to order (minimum quantities apply.)

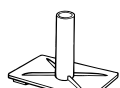

8707596400

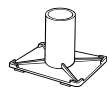

8701666800

### Display Pole Foot

- Anchor display poles with this sturdy foot
- Comes with two permanent adhesive strips
- Use with Display Poles (above)
- 8707596400 base size: 2" x 3.125"
- 8701666800 base size: 2.5" x 3.5"
- White polystyrene

Item No.	Ref. No.	Fits Pole	Capacity	Pack
8707596400	-	D	.830" O.D.	1
8701666800	-	A	1.468" O.D., 1.25" I.D.	1

### Wire Foot WF-24

- Two-piece set of overlapping wires slips inside display pole base to create a sturdy foot
- Available in three sizes for different diameter poles
- 24" span
- Steel

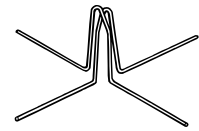
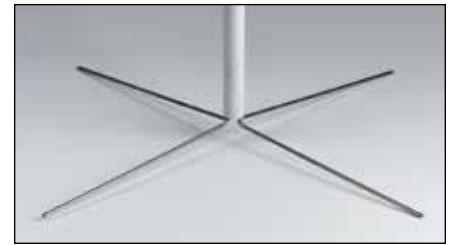

Item No.	Ref. No.	Fits Pole	Pole I.D.	Pack
8707784101	-	D	.8125" I.D.	1
8707784102	-	B	1.25" I.D.	1
8707784103	-	A	1.468" I.D.	1

### Pole Gripper with SuperGrip® Sign Holder

- SuperGrip® brand holding power for signs
- Flexible ribs grip tube to prevent sign rotation
- Clips onto 1" or 1.5" O.D. poles or tubes
- Holds material up to .1875" thick
- 3" long
- Clear PVC

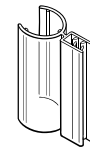

Item No.	Ref. No.	Fits Pole	Dimensions	Pack
8708800601	-	D	1" O.D.	1
8708800602	-	B	1.5" O.D.	1

Additional lengths and colors can be made to order (minimum quantities apply.)

### Premier™ Pole Gripper

- Add signage, literature holders or lightweight displays to most Premier™ banner stands or other display poles; fits .75" or 1" diameter poles
- Flexible ribs grip tube to prevent rotation
- Mount displays with fasteners using two .125" diameter holes; with Adhesive Pads
- .75" W x 4" H mounting area
- Clear PVC

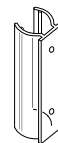

Item No.	Ref. No.	Fits Pole	Finish	Pack
8707740401	-	D	Clear	1

### SuperGrip® Sign Holder for Display Poles 2247

- Add signage to display pole tops with slide-in holder
- Features SuperGrip® brand holding power
- Holds signage up to .1875" thick
- 3" long
- White polystyrene base / Clear PVC sign holder

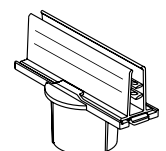

Item No.	Ref. No.	Fits Pole	Pole Dimensions	Pack
8718178201	-	B or D	1.25" I.D. or 1" O.D.	1

Additional colors can be made to order (minimum quantities apply.)

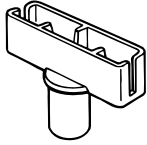

### Top Sign Holder 2247

- Holds signs securely atop display poles
- Holds .018" to .060" thick materials
- 3" L
- Clear polystyrene

Item No.	Ref. No.	Fits Pole	Pole Dimensions	Pack
8708146800	-	A or D	1.468" I.D. or 1" O.D.	1

Additional colors can be made to order (minimum quantities apply.)

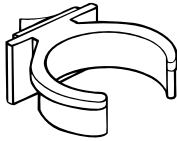

### Pole Gripper 2221

- Pole clips into gripper to anchor pole to display
- Attaches to most flat surfaces with permanent adhesive
- White polystyrene

Item No.	Ref. No.	Fits Pole	Pole Dimensions	Pack
8702023402	-	D	1" - 1.25" O.D.	1
8702441502	-	A or B	1.5" - 1.75" O.D.	1

Additional colors can be made to order (minimum quantities apply.)

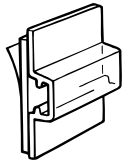

### Adhesive Strap Clip PG-513

- Locking strap slides through clip and secures pole to a variety of display or structural surfaces
- Attaches to most flat surfaces with permanent adhesive
- Shown with Display Pole
- Compatible with LK Permanent Locking Strap, Solid Style (1701804503)
- Clear butyrate

Item No.	Ref. No.	Dimensions	Finish	Pack
8702035100	-	1" W x 1.375" H	Clear	1



### Wire Spring WS-80

- A fast way to anchor display poles to various fixtures
- Features hooks at both ends
- 1.5" long
- 3" diameter suggested maximum capacity
- Metal
- Packaged and sold: 2 per bag

Item No.	Ref. No.	Dimensions	Finish	Pack
8708004100	-	1.5" L	Silver	2



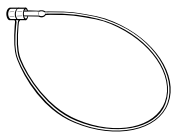

**Locking Strap, Fixed Style**

- Securely affixes to product, vinyl pouches and fixtures without interfering with product presentation
- Locks permanently for a tamper-free attachment – must be cut to remove
- 5" L (1.5" I.D. loop)
- Natural nylon
- Packaged: 500/bag

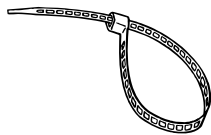

**Permanent Locking Strap, Ladder Style**

- Locks permanently for a tamper-free attachment – must be cut to remove
- Notched full length
- .125" wide
- Natural nylon

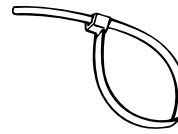
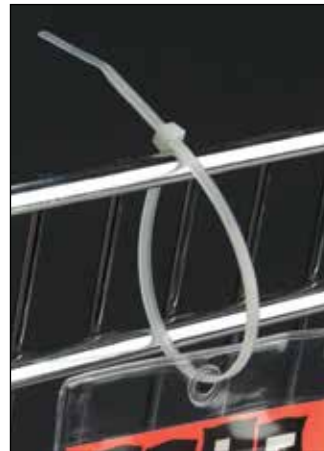

**Permanent Locking Strap, Solid Style**

- Adjusts easily; locks securely and permanently
- Ideal for any application
- Natural or black nylon
- 1707955602 Packaged and sold: 50/bag only
- 1707955603 Packaged and sold: 100/bag only



**Releasable Locking Strap**

- Reuseable yet secure
- Can be locked anywhere along full length
- .1875" wide
- Natural nylon

Item No.	Ref. No.	Dimensions	Finish	Pack
<b>Locking Strap, Fixed Style</b>				
1701722302	-	5" L	Natural	500
<b>Permanent Locking Strap, Ladder Style</b>				
1701804502	-	7" L	Natural	1
1701804505	-	11" L	Natural	1
<b>Permanent Locking Strap, Solid Style</b>				
1701804501	RIS-CBL-4	4" L	Natural	1
1701804500	-	4" L	Black	1
1701804503	RIS-CBL-TIE	8" L	Natural	1
1701804512	-	8" L	Black	1
1704636900	RIS-CBL-11	11" L	Natural	1
1704636901	-	11" L	Black	1
1701804514	-	17" L	Natural	1
1701804554	-	17" L	Black	1
1701804562	-	24" L	Natural	1
1707955602	-	36" L	Natural	50
<b>Releasable Locking Strap</b>				
1702520102	-	6" L	Natural	1
1702520104	-	10" L	Natural	1

Additional lengths can be made to order (minimum quantities apply.)

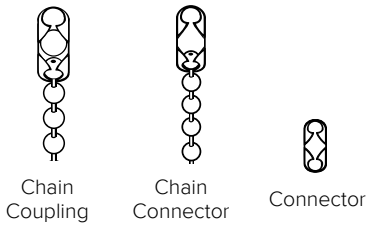

### Beaded Chain

- Add product information, color chips and promotional signage almost anywhere in store
- Chain clips together for a secure fit
- Available in connector and coupling styles
- Connector style provides a solid attachment with fixed chain length
- Coupling style allows chain to adjust to any length
- Connector can be used for a solid attachment and fixed length
- #3 and #6 nickel chain

Item No.	Ref. No.	Chain	Dia.	Dimensions	Pack
<b>Chain Coupling</b>					
6402212505	-	#6	.125"	6" L	1
6402212506	-	#6	.125"	12" L	1
6402212507	-	#6	.125"	24" L	1
<b>Chain Connector</b>					
6402293801		#3	.093"	6" L	1
6402293802	RBC-CN312	#3	.093"	12" L	1
6402293803	-	#3	.093"	24" L	1
6402212501	RBC-CN660	#6	.125"	6" L	1
6402212502	RBC-CN612	#6	.125"	12" L	1
6402212503	RBC-CN624	#6	.125"	24" L	1

Additional sizes can be made to order (minimum quantities apply).



### Beaded Chain with A-Hooks

- Use chain to hang promotional signage, product information, or banner displays almost anywhere in store
- Hook style allows easy hanging of chains from ceiling or hanging accessories
- Hook: 1.25" H x .6875" W; .375" H x .25" W inner dimension to hook onto attachment
- #6 silver nickel-plated brass

Item No.	Ref. No.	Chain	Dimensions	Pack
6400000012	-	#6	12" L	1

Additional sizes can be made to order (minimum quantities apply).

## Metal Pegboard Baseplate

- Use to mount displays to standard pegboard
- Available with or without .25" diameter mounting hole; can be used with fasteners
- Can use adhesive pads or spot weld to metal accessories for mounting
- 1" L x .875" H mounting area
- 16-gauge zinc-plated metal

Item No.	Ref. No.	Style	Finish	Pack
7108360001	-	w/o hole	Silver	1
7154283382	-	w/ .25" dia hole	Silver	1

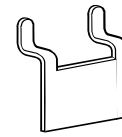
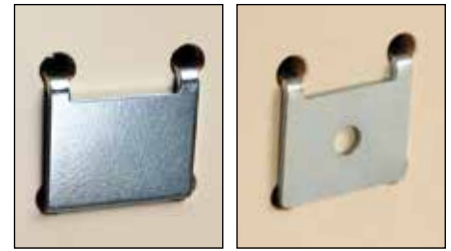

7108360001

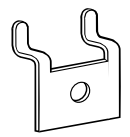

7154283382

## Spider Clip SP8-78

- Mounts Pop-Up® brand products and lightweight displays directly to standard 1.25" shelf channels
- Mounts with two attached dart clips
- Shown with 9102499801, Pop-Up® Literature Box
- Natural polypropylene

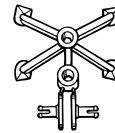

Item No.	Ref. No.	Style	Finish	Pack
8401656800	-	Shelf Channel	Natural	1

## Metal C-Clamp Bracket

- Fits shelves or other fixtures up to 1.5" thick
- 1.75" H x .75" W mounting area; features two .1875" diameter mounting holes
- Sign style is notched to be compatible with any of the Sign Holders/Adapters
- Attach displays using Adhesive Pads, fasteners or by tack welding
- Can also slide displays onto mounting plate (.0625" capacity)
- Zinc-plated metal

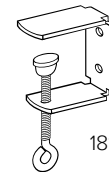

1812524300

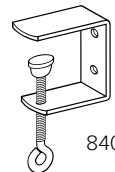

8401277701

Item No.	Ref. No.	Style	Finish	Pack
1812524300	-	Sign - w/ Notch	Silver	1
8401277701	-	Display - w/o Notch	Silver	1

## Channel Mount Adapter

- Fits most shelf channels
- 3" L with four .1875" mounting holes
- Thumb screw provides secure fit into shelf channel
- Literature Boxes can be attached with Viking Clip or Adhesive Pads
- Steel

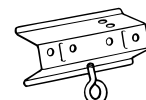

Item No.	Ref. No.	Dimensions	Finish	Pack
8408087600	-	3" L	Silver	1

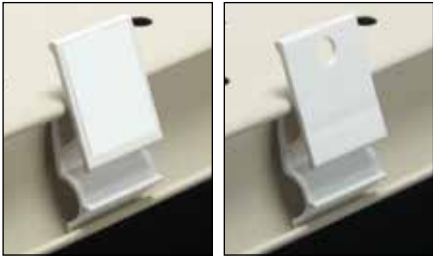

8402281203 8402281202

### Shelf Extender Clip SHX83

- Fits into shelf channels extending above or below shelf to hold displays, literature holders or merchandising strips
- Available with .25" diameter hole or with adhesive
- Fits most standard 1.25" shelf channels
- 1" long
- White butyrate

Item No.	Ref. No.	Style	Finish	Pack
8402281202	-	.25" hole	White	1
8402281203	-	w/ adh	White	1

Additional lengths and colors can be made to order (minimum quantities apply.)

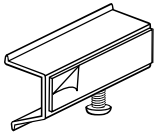

### Shelf Channel Adapter

- Mount literature holders, coupon dispensers and lightweight displays to shelf channels
- 2.5" L x 1.25" H x 1" D
- Permanent adhesive provides a secure hold
- Beige ABS

Item No.	Ref. No.	Dimensions	Finish	Pack
0606780802	-	2.5" L x 1.25" H x 1" D	Beige	1

Additional colors can be made to order (minimum quantities apply.)

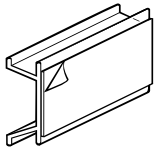

### Channel Mount with Adhesive

- Fits most standard 1.25" shelf channels
- Securely holds a variety of signs and displays
- 1.25" H x 2" L
- Permanent adhesive: 1" H x 2" L
- Clear PVC

Item No.	Ref. No.	Dimensions	Finish	Pack
0601277701	-	1.25" H x 2" L	Clear	1

Additional lengths and colors can be made to order (minimum quantities apply.)

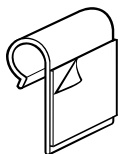

### J-Hook with Adhesive

- Securely holds signs and displays on wire or corrugated
- Permanent adhesive holds a variety of materials
- Fits up to .3125" diameter wire
- Shown with Wire Power Wing
- .75" L x 1" H
- White HIPS

Item No.	Ref. No.	Dimensions	Finish	Pack
1402597601	-	.75" L x 1" H	White	1

Additional lengths and colors can be made to order (minimum quantities apply.)



### Slatwall Adapter

- Holds signs and lightweight displays flush against slatwall
- Can be used with Insta-Flag™ Display Bases
- Fits all standard slatwall grooves
- Permanent adhesive provides a secure hold
- White polystyrene

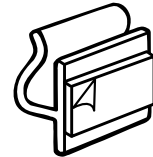

Item No.	Ref. No.	Dimensions	Finish	Pack
2501687002	-	1" W	White	1

Additional lengths can be made to order (minimum quantities apply.)

### Slatwall Wide Adapter

- Wider adapter, to hold lightweight displays or sign holders such as wall-mount sign holders flush against slatwall
- Permanent adhesive provides a secure hold
- White or clear polystyrene

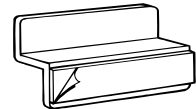

Item No.	Ref. No.	Dimensions	Finish	Pack
7108156000	-	2.35" W	White	1
7108156002	-	2.35" W	Clear	1

Additional colors can be made to order (minimum quantities apply.)

### Pegboard/Slatwall Adapter

- Holds lightweight displays flush against pegboard or slatwall
- Available with or without permanent adhesive
- Fits standard .25" pegboard holes

#### 2-Prong Adapter

- Hooks are spaced 2" on center; 2.375" L
- Available with and without adhesive
- White or clear high-impact plastic

#### 4-Prong Adapter

- Hooks are spaced 1" on center; 3.5" long
- Natural polypropylene

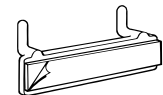

7101997200

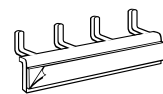

7102799100

Item No.	Ref. No.	Style	Finish	Pack
<b>2-Prong</b>				
7101997200	-	w/ adh	White	1
7101997202	-	w/ adh	Clear	1
7101997203	-	w/o adh	Clear	1
<b>4-Prong</b>				
7102799100	-	w/ adh	Natural	1

Additional colors can be made to order (minimum quantities apply.)

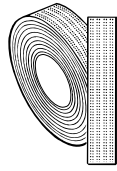

880811904

### Self-Engaging Fastener

- Secure hook-to-hook attachment ideal for heavy-duty use
- Low profile (.01" engaged thickness) is unobtrusive
- White high-density polyethylene with clear rubber-based adhesive
- Roll: 1" W x 50 yards; Sold in full rolls only

Item No.	Ref. No.	Dimensions	Finish	Pack
880811904	-	1" W x 50 yards	White	Roll



Now in .5" Tape and .625 Buttons

### Hook and Loop Fasteners

- Available in adhesive-backed continuous roll tape or buttons
- White or black woven nylon with permanent adhesive backing
- .75" Buttons packaged: 1,028 per roll
- .875" Buttons packaged: 900 per roll
- Sold in full rolls only
- See website for additional colors

Item No.	Ref. No.	Dimensions	Finish	Pack
<b>Tape</b>				
8801420001	-	.5" Hook	White	25 yd / Roll
8801420002	-	.5" Loop	White	25 yd / Roll
8808145902	R16-3/4-HTE	.625" Hook	White	25 yd / Roll
8808173502	R16-3/4-LTE	.625" Loop	White	25 yd / Roll
8808145906	-	1" Hook	White	25 yd / Roll
8808173506	-	1" Loop	White	25 yd / Roll
<b>Buttons</b>				
8804701201	-	.625" Hook	White	Roll
8804701202	-	.625" Loop	White	Roll
8807998103	R16-3/4-HCE	.75" Hook	White	Roll
8808018003	R16-3/4-LCE	.75" Loop	White	Roll
8807998106	-	.875" Hook	White	Roll
8808018006	-	.875" Loop	White	Roll

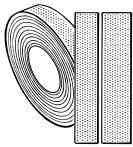

8808145902



8807998103

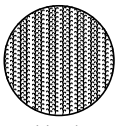

Hook (rough)



Loop (smooth)

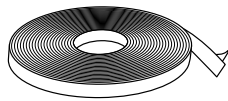

### Finger Lift Double-Sided Tissue Tape/Permanent

- Tissue liner overlaps at edges for easy liner removal
- Double-sided tape roll with permanent adhesive on both sides
- General purpose tape ideal for paper products, lightweight POP and posters
- Clear tape in 1,300' continuous roll; sold in full rolls only

Item No.	Ref. No.	Dimensions	Finish	Pack
8601161212	-	.75" W	Clear	Roll

Additional sizes can be made to order (minimum quantities apply.)

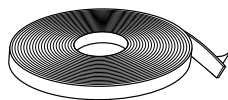

### Finger Lift Double-Sided Film Tape/Permanent

- Polyester liner overlaps at edges for easy liner removal
- Double-sided, high-bond film tape roll with permanent adhesive on both sides
- High performance adhesive ideal for a variety of applications
- Clear tape in 1,080' continuous roll; sold in full rolls only

Item No.	Ref. No.	Dimensions	Finish	Pack
8601161216	S-DBLTAPE-1/2IN	.5" W	Clear	Roll
8601161217	S-DBLTAPE-1IN	.75" W	Clear	Roll

Additional sizes can be made to order (minimum quantities apply.)

## Double-Sided Clear Adhesive Film Tape/Permanent

- Aesthetically pleasing clear thin film – create nearly invisible bond lines
- Ideal for most smooth surfaces including clear plastics (such as literature holders) and UV coatings
- Double-sided, high-bond film tape with permanent clear adhesive on both sides
- Bonds to most plastics and acrylics and is stable in UV light
- Tape has a red backing which pulls off during application
- Continuous roll delivers flexibility to cut to any size
- Clear film tape in 180' continuous roll; sold in full rolls only

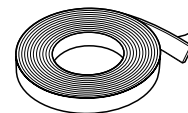

Item No.	Ref. No.	Dimensions	Finish	Pack
8601948508	-	.5" W x .008" D	Clear	Roll

Additional sizes can be made to order (minimum quantities apply.)

## Double-Sided Clear Adhesive Tape/Permanent

- Aesthetically pleasing tape – create nearly invisible bond lines
- Ideal for bonding clear plastics (e.g. literature holders) and is stable in UV-light
- Double-sided clear high bond tape roll with permanent acrylic adhesive on both sides
- Good conformability on irregular surfaces
- Bonds to most plastics and acrylics
- Tape has a red backing which pulls off during application
- Continuous roll delivers flexibility to cut to any size
- Clear tape in 108' continuous roll; sold in full rolls only

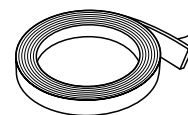

Item No.	Ref. No.	Dimensions	Finish	Pack
8601948500	-	.5" W x .040" D	Clear	Roll
8601502100	-	1" W x .040" D	Clear	Roll

Additional sizes can be made to order (minimum quantities apply.)

## Double-Sided Foam Tape/Permanent

- Double-sided foam tape roll with high tack permanent adhesive on both sides
- Bonds to low surface energy plastics, powder-coated materials, and some UV coatings
- Typical applications include paper, cardboard, plastic, and PVC foam boards
- Available in multiple sizes; continuous roll delivers flexibility to cut to any size
- White foam tape in 216' continuous roll; sold in full rolls only

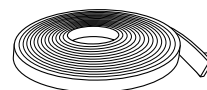

Item No.	Ref. No.	Dimensions	Finish	Pack
8601161200	-	.5" W x .0625" D	White	Roll
8601406300	-	1" W x .0625" D	White	Roll
8601321200	-	.5" W x .03125" D	White	Roll
8609260800	-	1" W x .03125" D	White	Roll

Additional sizes can be made to order (minimum quantities apply.)

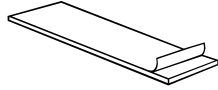

### Double-Sided Pre-Cut Foam Tape, Permanent

- Pre-cut double-sided foam tape with high tack permanent adhesive on both sides
- Bonds to low surface energy plastics, powder-coated materials and some UV coatings
- Typical applications include paper, cardboard, plastic, and PVC foam boards
- Available in multiple sizes; pre-cut for ease of use and labor savings
- White foam tape
- Continuous liner style sold in full rolls of 1,000 or 5,000 only
- Perforated liner style sold in partial or full rolls of 20,000; liner is perforated in 18 piece sheets

Item No.	Ref. No.	Style	Dimensions	Pack
8601965901	-	Continuous (1,000)	.5" W x 1" L x .0625" D	Roll
8602165700	-	Perforated	.5" W x 1" L x .0625" D	Roll
8602389402	RFMTP-1X1-2P	Continuous (5,000)	.75" W x 2.75" L x .0625" D	Roll
8601382900	-	Continuous (5,000)	.75" W x 2.75" L x .03125" D	Roll

Additional sizes can be made to order (minimum quantities apply.)

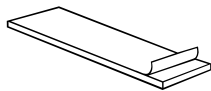

### Double-Sided Pre-Cut Foam Tape Permanent/Removable

- Pre-cut double-sided white foam tape with high tack permanent adhesive on one side and removable adhesive on the other side
- Removable adhesive cleanly removes from most hard, non-delaminating surfaces
- Ideal for displaying promotional or temporary signage on non-delaminating surfaces
- White foam tape
- Continuous liner style sold in full rolls of 5,000 only
- Perforated liner style sold in partial or full rolls of 5,000; liner is perforated in 18 piece sheets

Item No.	Ref. No.	Style	Dimensions	Pack
8607861200	-	Perforated	.5" W x 1" L x .0625" D	Roll
8601959600	RFMTP-1X1-2R	Continuous	.75" W x 2.75" L x .0625" D	Roll

Additional sizes can be made to order (minimum quantities apply.)

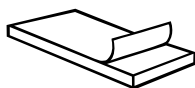

### Double-Sided Pre-Cut Foam Tape Removable/Removable

- Pre-cut double-sided white foam tape with removable adhesive on both sides
- Ideal for displaying temporary signage on non-delaminating surfaces
- Two-sided removable adhesive is ideal for kit pack-outs where facilitating the installation is critical
- White foam tape
- Continuous liner style sold in full rolls of 5,000 only
- Perforated liner style sold in partial or full rolls of 5,000; liner is perforated in 18 piece sheets

Item No.	Ref. No.	Style	Dimensions	Pack
8601879401	-	Perforated	.5" W x 1" L x .0625" D	Roll
8602034500	-	Continuous	.75" W x 2.75" L x .0625" D	Roll

Additional sizes can be made to order (minimum quantities apply.)

### Foam Block Stand-Off

- Double-sided foam block adds dimension to displays and signage with 3-D presentation
- Available with permanent adhesive on both sides or removable adhesive on one side
- Easy peel-and-stick application
- Two sizes: 1" H x 1" W x .5" D and 1" H x 1" W x 1" D
- White or black foam block
- Sold in full sheets only



Now in Black 1" H x 1" W x .5" D

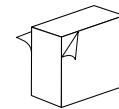

8605694801

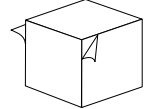

8605694802

Item No.	Ref. No.	Finish	Dim.	Adhesive	Pack
8605694801	-	White	.5" D	Perm/Perm	10/sheet
8601296601	-	White	.5" D	Perm/Removable	12/sheet
8605694806	-	Black	.5" D	Perm/Perm	10/sheet
8605694802	-	White	1" D	Perm/Perm	20/sheet
8605694807	-	Black	1" D	Perm/Perm	20/sheet
8609168601	-	White	1" D	Perm/Removable	36/sheet

Additional sizes and colors can be made to order (minimum quantities apply)

### Re-POP™ Clear Adhesive Pad

- Redesigned to provide a stronger hold with a thinner profile
- Attaches temporary signage or lightweight displays to a wide variety of surfaces
- Pliable adhesive pad with clear acrylic-based adhesive on both sides
- Applies and removes easily without damaging hard materials or leaving adhesive residue
- Recommended application temperature between 65°F and 100°F
- Priced per sheet; sold in full sheets of four pads

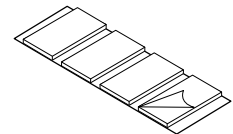

Item No.	Ref. No.	Dimensions	Finish	Pack
8602185001	-	1.5" L x .75" W x .03125" thick	Clear	4/sheet

### Flexible Magnets

- Scored magnetic rolls are available in two different magnet sizes with clear permanent adhesive backing
- Available as pre-cut roll or continuous roll
- .0625" thick

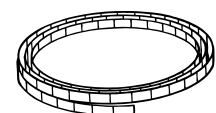

Item No.	Ref. No.	Style	Dimensions	Pack
8601936101	-	Pre-Cut	.5" W x 1" L	1,200/roll
8607695200	-	Pre-Cut	1" W x 2" L	600/roll
8601868601	-	Continuous Roll	1" W x 100'	Roll

Additional sizes can be made to order (minimum quantities apply)



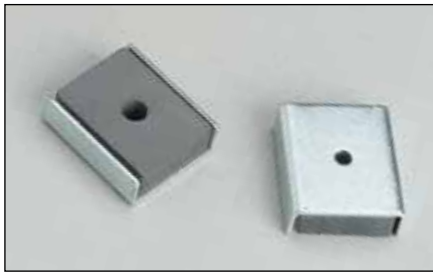

### Magnetic Adapter CH-10

- Versatile rubber magnet with nickel housing for use on metal surfaces and shelving
- Features integrated center hole
- 3" L housing available with 2 magnets, or 3 magnets for strongest hold
- Nickel housing
- **WARNING:** Do not use near sensitive electronic equipment

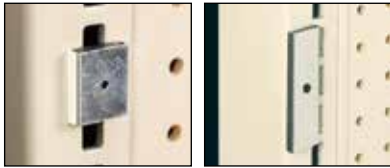

8607554201

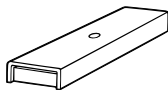

8607460001

Item No.	Ref. No.	Dimensions	Magnets	Pack
8607554201	-	1" L	1	1
8607460004	-	3" L	2	1
8607460001	-	3" L	3	1

*Additional sizes can be made to order (minimum quantities apply.)*



### Bumper Buttons

- Adhesive-backed buttons attach to the bottom of literature holders and other display components
- Prevents damage to shelves and other surfaces
- Clear polyurethane



8207511700

Item No.	Ref. No.	Dimensions	Finish	Pack
8207511701	RBMP-C05-1K	.5" O.D. x .0625" H	Clear	200
8207511700	RBMP-C01-1K	.5" O.D. x .125" H	Clear	200

*Additional sizes can be made to order (minimum quantities apply.)*

## Flipper Nut™ for Warehouse Upright

- Holds displays and fixtures securely onto warehouse uprights
- Front-access design allows easy installation
- Unique nut design engages fixture as bolt is tightened
- Nut size 1.180" L x .500" W with 14-20 threaded hole
- 1.250" L 1/4-20 Phillips head machine screw
- Packaged: 100 per bag

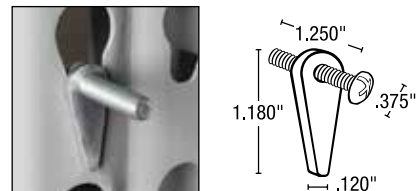

Item No.	Ref. No.	Dimensions	Finish	Pack
1502984101	-	1.180" L x .500" W	Silver	100

## Viking Clip

- Screw and wing nut fastener is a one-piece break-apart design
- .790" L screw with .500" head diameter
- 1" L screw with .5625" head diameter
- Fits .1875" diameter hole
- Clear polystyrene

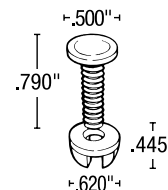

Item No.	Ref. No.	Dimensions	Finish	Pack
8507563101	RPS-V2K-FSTNR	.790" L	Clear	1
8507501000	-	1" L	Clear	1

Additional colors can be made to order (minimum quantities apply.)

## Squeeze-On Viking Clip

- Fast-attaching squeeze-on nut to save time in assembly of displays
- Unique one-piece break-apart design
- .880" L screw with .490" head diameter; fits .1875" diameter hole
- Clear polycarbonate

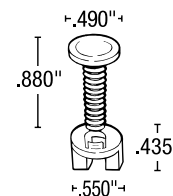

Item No.	Ref. No.	Dimensions	Finish	Pack
8506495201	-	.880" L	Clear	1

Additional colors can be made to order (minimum quantities apply.)

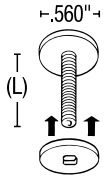

### Quick-Grip Fastener

- One-piece break-apart design is ideal for fast, secure installation
- Fits .1875" diameter holes
- Head diameter .560"
- .1250" to 1.125" capacity
- Clear K-Resin®

Item No.	Ref. No.	Cap.	Length (L)	Finish	Pack
8507936700	-	.1250"	.254" L	Clear	1
8507552101	-	.2500"	.440" L	Clear	1
8507552102	R16-PAN-38	.3750"	.560" L	Clear	1
8507552103	R16-PAN-12	.5000"	.690" L	Clear	1
8507552105	R16-PAN-34	.6250"	.810" L	Clear	1
8507552107	-	.8750"	1.050" L	Clear	1
8507552108	-	1.125"	1.300" L	Clear	1

Additional colors can be made to order (minimum quantities apply.)

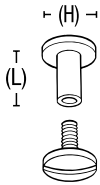

### Adjust•A•Lok

- A quick-connect display panel fastener with slotted heads
- Plastic fasteners fit .2500" diameter holes
- Aluminum fasteners fit .2188" diameter holes
- White polyethylene (female) / nylon (male) or silver aluminum

Item No.	Ref. No.	Head (H)	Cap.	Length (L)	Finish	Pack
<b>Plastic</b>						
8507484801	-	.5625"	.2500"	.250" L	White	1
<b>Aluminum</b>						
8502034500	-	.4063"	.5000"	.510" L	Silver	1
8500600401	-	.4063"	.7500"	.750" L	Silver	1

Additional sizes can be made to order (minimum quantities apply.)

## Ratchet Rivet RR-2525

- Two-piece quick fastener, available in various sizes
- Fits .2813" diameter holes
- Natural or black nylon
- Two pieces per set; priced per set



Item No.	Ref. No.	Head (H)	Cap.	Finish	Pack
8506232201	RRL-600	.400"	.250"	Natural	1 Set
8500000100	RRL-833	.400"	.500"	Natural	1 Set
8506232202	RRL-226	.750"	.250"	Natural	1 Set
8500000101	RRL-488	.750"	.500"	Natural	1 Set
8500000106	-	.750"	.780"-1.375"	Natural	1 Set

*Additional sizes and colors can be made to order (minimum quantities apply.)*

## Toggler TA-100

- Ingenious .560" head fastener with extra holding power
- Easy to use – simply squeeze the stem, insert into hole and use key to spread the toggler
- Fits .3125" diameter holes; .250" capacity
- Three keys per 100-count box of togglers
- Natural polypropylene
- Packaged and sold: 100/box

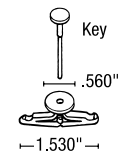

Item No.	Ref. No.	Dimensions	Finish	Pack
8507910701	-	1.53" W	Natural	100

*Additional sizes and colors can be made to order (minimum quantities apply.)*

## Arrowhead® Thumbsnap AF408

- One-piece fastener securely holds a variety of panel sizes
- Fits .250" diameter holes
- Head diameter .500"
- Natural polypropylene



Item No.	Ref. No.	Head (H)	Cap.	Length (L)	Pack
8501936203	-	.500"	.250"	.650"	1

*Additional sizes and colors can be made to order (minimum quantities apply.)*

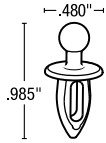

### Pegboard Paper/Vinyl Fastener

- Push-fit fastener is easy to install and remove without damage to pegboards
- Ideal for pegboard, paper or vinyl
- Head base of .48"
- Fits .250" diameter holes, with .25" capacity; fits most pegboard holes
- .985" L
- Natural polypropylene

Item No.	Ref. No.	Head (H)	Capacity	Pack
8502526600	-	.480"	.250"	1

Additional sizes and colors can be made to order (minimum quantities apply.)

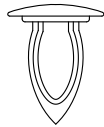

### EZ-Remove Push Pin

- Unique, raised-head design for easy removal.
- Slightly tapered barrel of pin provides strong hold while being easy to pull out.
- Ideal for placement of temporary graphics or display components.

Item No.	Ref. No.	Length	Hole Size	Head O.D.	Head Style	Finish	Pack
8509866214	R16-CTP-025C	.625"	.25"	.50"	Flat	Clear	200

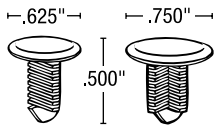

8532988000      8508012300

### Channel Fastener

- Easy to install and remove
- Secure fit in .250" diameter shelf holes
- Capacity up to .375"
- CF1C head diameter .625"; CT2530 head diameter .750"
- Natural, white or black nylon

Item No.	Ref. No.	Style	Head Dia.	Finish	Pack
8532988000	R16-TREE-P1	CF1C	.625"	Natural	1
8532988002	-	CF1C	.625"	White	1
8532988003	-	CF1C	.625"	Black	1
8508012300	-	CT2530	.750"	Natural	1

Additional colors can be made to order (minimum quantities apply.)

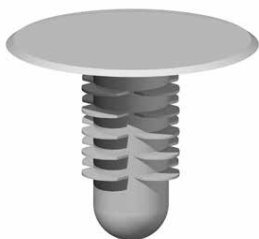

### Perforated Shelf Fastener

- Ideal for steel shelving

Item No.	Ref. No.	Length	Hole Size	Head O.D.	Head Style	Finish	Pack
8504270066	R16-PSR-12	.50"	.234"	.609	Flat	White	1000



## Universal Fastener

- Easy to remove and reuse
- Fits most standard perforated shelves; .250" hole
- Natural or black nylon

### Standard

- Capacity .187"
- Head diameter .430"

### Low Profile

- Capacity .25"
- Head diameter .240"

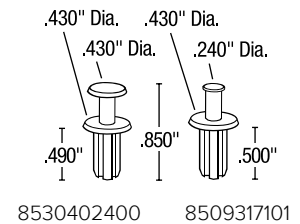

Item No.	Ref. No.	Style	Finish	Pack
8530402400	R16-PSD2-PP-	Standard	Natural	1
8530402437	-	Standard	Black	1
8509317101	-	Low Profile	Natural	1
8509317100	-	Low Profile	Black	1

Additional colors can be made to order (minimum quantities apply.)

## Wing Nut & Bolt

- Holds heavier displays securely
- Includes 10-32 wing nut, 10-32 machine screw, and flat washer
- Metal nut and screw, nylon washer

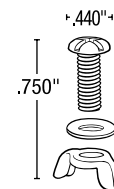

Item No.	Ref. No.	Dimensions	Finish	Pack
8535553601	-	.750" L	Silver	1

Additional sizes and colors can be made to order (minimum quantities apply.)

## Plastic Loop Fastener

- Unique loop design holds a variety of signs and displays
- Fits most standard perforated shelves, recommended for diamond-shaped holes
- Head diameter .470"
- Natural polypropylene

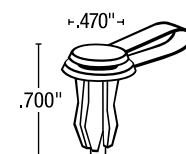

Item No.	Ref. No.	Capacity	Finish	Pack
8538485500	R16-LP-1	.187"	Natural	1

Additional sizes and colors can be made to order (minimum quantities apply.)

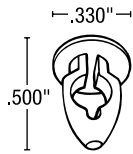
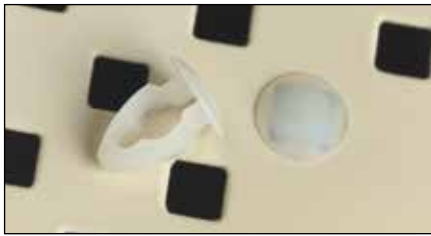

### Diamond Hole Shelf Dart E447

- Ideal for use with diamond-shaped shelf holes
- Holds up to .060" thick material
- Also fits .2188" diameter round holes
- Head diameter .330"
- Natural nylon

Item No.	Ref. No.	Capacity	Finish	Pack
8508411500	-	.0938"	Natural	1

*Additional colors can be made to order (minimum quantities apply.)*

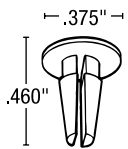

### Shelf Dart Clip E443

- Fits most .250" diameter shelf holes
- Head diameter .375"
- White HIPS

Item No.	Ref. No.	Capacity	Finish	Pack
8502101300	R16-009	.0938"	White	1

*Additional colors can be made to order (minimum quantities apply.)*

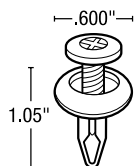

### Dart/Canoe Clip with Phillips Head

- Phillips head and screw-in feature offer additional security
- Fasten signage to corrugated displays and perforated shelves
- .6" diameter head, fits .250" diameter holes, with .25" capacity
- Black polypropylene

Item No.	Ref. No.	Dimensions	Finish	Pack
8509925400	-	1" L	Black	1

## Dart/Canoe Clip

- Quick and easy push-fit fastener is available in small and large versions
- Small Dart Clip: .400" head dia., fits .1875" dia. holes, .125" capacity
- Large Dart Clip: .490" head dia., fits .250" diameter holes, .25" capacity
- Small Dart: natural or black nylon; Large Dart: natural or black polypropylene

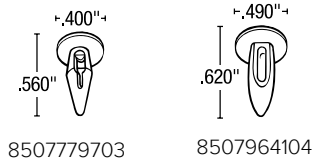

Item No.	Ref. No.	Dimensions	Finish	Pack
8507779703	-	Small	Natural	1
8507779704	-	Small	Black	1
8507964104	R16-1-030	Large	Natural	1
8507964105	-	Large	Black	1

Additional sizes and colors can be made to order (minimum quantities apply.)

## Tree Push Pin

- Most popular for displays
- Easy to insert with firm holding power
- Fits a variety of holes



Item No.	Ref. No.	Length	Hole Size	Head O.D.	Head Style	Finish	Pack
8504793505	R16-CTP-002N	.438"	.187"	.437"	Flat	Natural	1
8507677170	R16-CTP-006N	.945"	.234"	.500"	Binder	Natural	1
8502477405	R16-CTP-008N-	.800"	.250"	.695"	Round	Natural	1
8502477406	-	.800"	.250"	.695"	Round	Black	1
8502477408	-	.802"	.250"	.700"	Round	Natural	1
8507868300	R16-CTP-009N-	1.1"	.250"	.700"	Round	Natural	1
8500000201	-	1.1"	.250"	.700"	Round	Black	1
8507868320	-	1.06"	.250"	.700"	Round	Natural	1
8501731692	R16-CTP-010N	1.44"	.250"	1.00"	Flat	Natural	1
8502196752	R16-CTP-011N	.745"	.281"	.625"	Flat	Natural	1

## Universal Label Holder Tool

- Universal label holder tool is ideal for inserting tags into price channels.
- Universal tool also features a push pin remover to pry push pins out of pegboard or shelf perforations.
- Convenient shape forms to hand for ergonomic use.

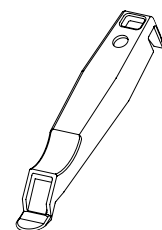

Item No.	Ref. No.	Dimensions	Finish	Pack
4407515844	R-UNITOOL-K10	5.25" L x .875" W x .625" D	Black	50



8503838349  
(Female)



8502259852  
(Male)

### Snap Rivet Fasteners

- Permanently locks flat panels together
- Requires male and female counterpart
- Priced and packed per piece, not per pair

Item No.	Ref. No.	Length	Hole Size	Head O.D.	Head Style	Finish	Pack
<b>Snap Rivet Fastener - Female</b>							
8503838349	R16-SR-F	-	.320"	.650"	Flat	White	1000
<b>Snap Rivet Fastener - Male</b>							
8502259852	R16-SR-M340	.3125"	.320"	.650"	Flat	White	1000



Before After

### Miracle Sticks

- Low cost solution to unsightly taping of signs.
- Double-sided tape sticks come in convenient rolls that peel off and apply easily.
- Plastic adhesive carrier stick allows for easy handling and removal with minimal adhesive residue.
- Save money through reduced labor in application and adhesive residue removal while making your promotional signs more attractive.
- Packed in rolls of 500 adhesive sticks.

Item No.	Ref. No.	Dimensions	Finish	Pack
8500978984	RMS-RL500	.375" W x 1.75" H	Clear	Roll



PATENTED



### Splash Rollz™ for Pegboard

- Add a splash of color to your existing pegboard fixtures!
- Roll out desired length marked every foot and cut Splash Rollz™ for Peg Board using the cutter and rail included.
- Use included push pins to place Splash Rollz™ in pegboard.
- Splash Rollz™ for Pegboard is available in five traditional colors: yellow, red, blue, green and black.
- Custom printed colors and patterns are also available.
- Features high quality, 65# text weight paper stock for brilliant, long lasting color.



Item No.	Ref. No.	Dimensions	Finish	Pack
8655675909	RGPC-116-46-Y	46" W x 150' L	Yellow	1 Roll
8657638517	RGPC-186-46-R	46" W x 150' L	Red	1 Roll
8659090656	RGPC-287-46-BL	46" W x 150' L	Blue	1 Roll
8658371999	RGPC-348-46-GR	46" W x 150' L	Green	1 Roll
8654821199	RGPC-BLK-46	46" W x 150' L	Black	1 Roll



# The Next Generation in Display Construction Solutions



Phone  
Fax  
Web

**800.422.2547**  
**800.422.2502**  
**www.siffron.com**

call toll-free in North America  
fax us your purchase order  
find and buy resources online





**siffron**<sup>®</sup>

See more great solutions  
on our website!

[www.siffron.com](http://www.siffron.com)  
800.422.2547